

The tap that does it all

100°C boiling, filtered chilled and sparkling water



Quooker®

The tap that does it all



Quooker's story started in 1970. Rotterdam-born Founder Henri Peteri was working at Unilever in the 1970s as part of the development team that invented instant soup. He believed that waiting for the kettle to boil meant that the soup was not truly instant. Born from his exasperation of waiting was the gem of an idea, instant boiling water, on tap. Peteri left Unilever and worked tirelessly in his basement to engineer a tap that could dispense instant, true 100°C water. Yet it wasn't until the early 1990s that the first Quooker tap was ready to be commercially launched in the Netherlands.

Now, Quooker produces over 200,000 Quookers a year, there are over 1 million in use throughout Europe and the UK.

The Peteri brothers always aimed to produce the most sustainable, energy-efficient and high-quality product. Now they head an internationally successful company. But, continuing in the spirit of their late father, they are still innovating.

Quooker®



Fusion Square black

Using a Quooker

Make coffee

Instant soup

Boil potatoes

Cook noodles and rice

Clean greasy pans

Clean chopping boards

Poach fish

Boil eggs

Pre-heat plates

Poach vegetables

Prepare baby bottle

Make tea

Sterilise dummies

Prepare sauce

Clean mixer

Skin tomatoes

Make broth or soup

Remove candle wax

Clean filter

Rinse plates

Filtered water

Make cocktails

Enjoy sodawater

The advantages of a Quooker



Safe

With a Quooker it's impossible to turn the boiling on accidentally. It requires a double-push and turn on an inconspicuous ring mechanism, which is completely separate from the regular cold and hot. The water is injected with air, and so is a fine spray which ensures the avoidance of accidental scalds or burns. Quookers have a double insulated spout, and so are cool to the touch, unlike kettles. Last but not least, you cannot accidentally knock, tip or 'spill' a Quooker as one can with a kettle or pan of boiling water.

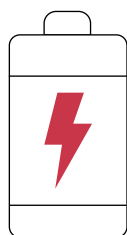

Energy efficient

Anyone who needs boiling water several times a day will not use more energy with a Quooker than with a kettle. With a Quooker COMBI tank (which provides both boiling and hot water all from a cold feed), you can even save energy. This is the first 'boiler' in the world with high-vacuum insulation, using 50 percent less energy than a household boiler. As the most energy-efficient hot water supply for the kitchen, the Quooker COMBI has an energy rating of A. Make your purchase even more sustainable by adding a Quooker CUBE that makes plastic water bottles redundant.

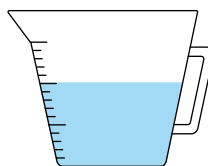

Water efficient

We all know it's important to be economical with water and yet, so many households unnecessarily waste it both in small amounts – for example if you boil twice as much water as you need – but also in larger amounts, when you let the tap run for a while until the water heats up. A Quooker helps you prevent wastage like this. With a Quooker CUBE, which also dispenses cool sparkling and filtered water, you also save on plastic water bottles!

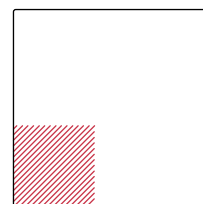

Space saving

Do you have a small kitchen? A Quooker saves precious space on your worktop. The space occupied by a kettle can be freed up to slice, knead and chop. And because the tank is so compact, there's still usable space under your worktop or in your kitchen cupboard.



Versatile

A Quooker is a kitchen appliance that can be used for a multitude of tasks. Whether it is tea or coffee, blanching vegetables or sterilising baby bottles or even cleaning dirty pans, the Quooker can do it all! With the Quooker Flex, which is equipped with an extendable hose, rinsing your sink or cleaning that chopping board just became even easier. The Quooker is also a great choice if you're looking to maximise work-top space and be rid of unsightly wires!

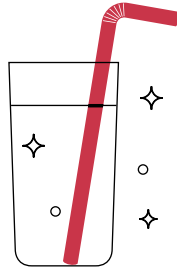

Tasty

How does it taste? Well.. An active carbon filter in the tank purifies every delivery of boiling water. Furthermore, because the tank keeps it under pressure, at a temperature of 110 °C it remains constantly fresh. This technology keeps the water hot without needing to use much energy, which translates to very minimal running costs. The Quooker CUBE is fitted with a Hollow Fibre filter and an Active Carbon filter that removes any bacteria from the water, giving you instantly chilled, fresh water every time.

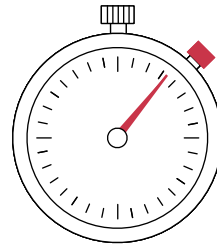

Time saving

The average person spends four months of their life waiting for a kettle to boil – but with Quooker, you'll never have to wait for your kettle to boil again! Once installed, the Quooker will undoubtedly become your most used appliance in the kitchen. As the boiling tank is constantly replenishing, you'll always have instant, fresh boiling water on tap. With our CUBE accessory, you will also have filtered chilled and sparkling water at your fingertips, meaning less supermarket trips for bottled water!

Choose your tap



Flex stainless steel

Front



Height: 255 mm
Reach: 292 mm
Tap hole: Ø 35 mm
Rotation: 270 °



stainless steel



black

Flex



Height: 412 mm
Reach: 220 mm
Tap hole: Ø 35 mm
Rotation: 270 °



polished chrome



stainless steel



black

Fusion Square



Height: 291mm
Reach: 220mm
Tap hole: Ø 35 mm
Rotation: 360 °



polished chrome



stainless steel



black



patinated brass



gold

Fusion Round



Height: 366 mm
Reach: 220 mm
Tap hole: Ø 35 mm
Rotation: 360 °



polished chrome



stainless steel



black



patinated brass



gold

Classic Fusion Square



Height: 291 mm
Reach: 220 mm
Tap hole: Ø 35 mm
Rotation: 360°



polished
chrome



stainless
steel



patinated
brass

Classic Fusion Round



Height: 366 mm
Reach: 220 mm
Tap hole: Ø 35 mm
Rotation: 360°



polished
chrome



stainless
steel



nickel



patinated
brass

Classic Nordic Square single tap



Maximum-height: 350 mm
Minimum-height: 115 mm
Reach: 160 mm
Tap hole: Ø 32 mm



polished
chrome



stainless
steel

Classic Nordic Round single tap



Maximum-height: 405 mm
Minimum-height: 170 mm
Reach: 160 mm
Tap hole: Ø 32 mm
Rotation: 360°



polished
chrome



stainless
steel



nickel

Nordic Square Twintaps



Height: 270 mm
Reach: 220 mm
Tap hole: Ø 35 mm
Rotation: 360°

Maximum-height: 350 mm
Minimum-height: 115 mm
Reach: 160 mm
Tap hole: Ø 32 mm
Rotation: 360°



polished
chrome



stainless
steel

Nordic Round Twintaps



Height: 345 mm
Reach: 220 mm
Tap hole: Ø 35 mm
Rotation: 360°

Maximum-height: 405 mm
Minimum-height: 170 mm
Reach: 160 mm
Tap hole: Ø 32 mm
Rotation: 360°

Nordic Square single tap



Maximum-height: 350 mm
Minimum-height: 115 mm
Reach: 160 mm
Tap hole: Ø 32 mm
Rotation: 360°



polished
chrome



stainless
steel

Nordic Round single tap



Maximum-height: 405 mm
Minimum-height: 170 mm
Reach: 160 mm
Tap hole: Ø 32 mm
Rotation: 360°



Nordic soap dispenser gold and Fusion Square gold



Nordic soap dispenser gold and Fusion Round gold

The tanks

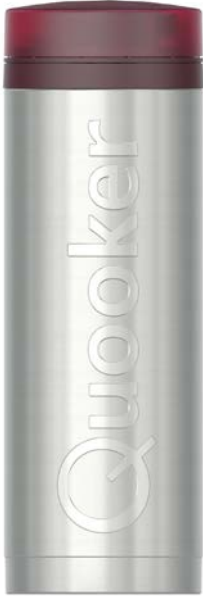

PRO3

Provides three litres of instant boiling water.

Diameter	153 mm
Height	467 mm
Heating-up time	10 minutes*
Power	1600W
Standby power consumption	10W
Volume 100°C	3 litres
Energy label	none**
Mounting bracket available	yes

PRO7

Provides seven litres of instant boiling water.

Diameter	199 mm
Height	468 mm
Heating-up time	20 minutes*
Standby power consumption	10W
Volume 100°C	7 litres
Energy label	none**
Mounting bracket available	yes

COMBI

Provides seven litres of instant boiling water or 27 litres of hot water (40°C) all from a cold feed.

No more waiting for hot water with the Quooker COMBI or dealing with low hot water pressure. Furthermore, it is the first 'boiler' with high-vacuum insulation. This makes it the most energy-efficient hot and boiling water provision for the kitchen.

Diameter	200 mm
Height	472 mm
Heating-up time	20 minutes*
Standby power consumption	10W
Volume 100°C	7 litres
Volume 60°C	15 litres
Volume 40°C	27 litres
Energy label	A
Mounting bracket available	yes

* These values are averages. ** PRO3 and PRO7 tanks only produce boiling water. The EU has no energy label guideline for boiling water tanks. However, these tanks are equally economical.

Choose your tank

Which tank will best suit your kitchen?

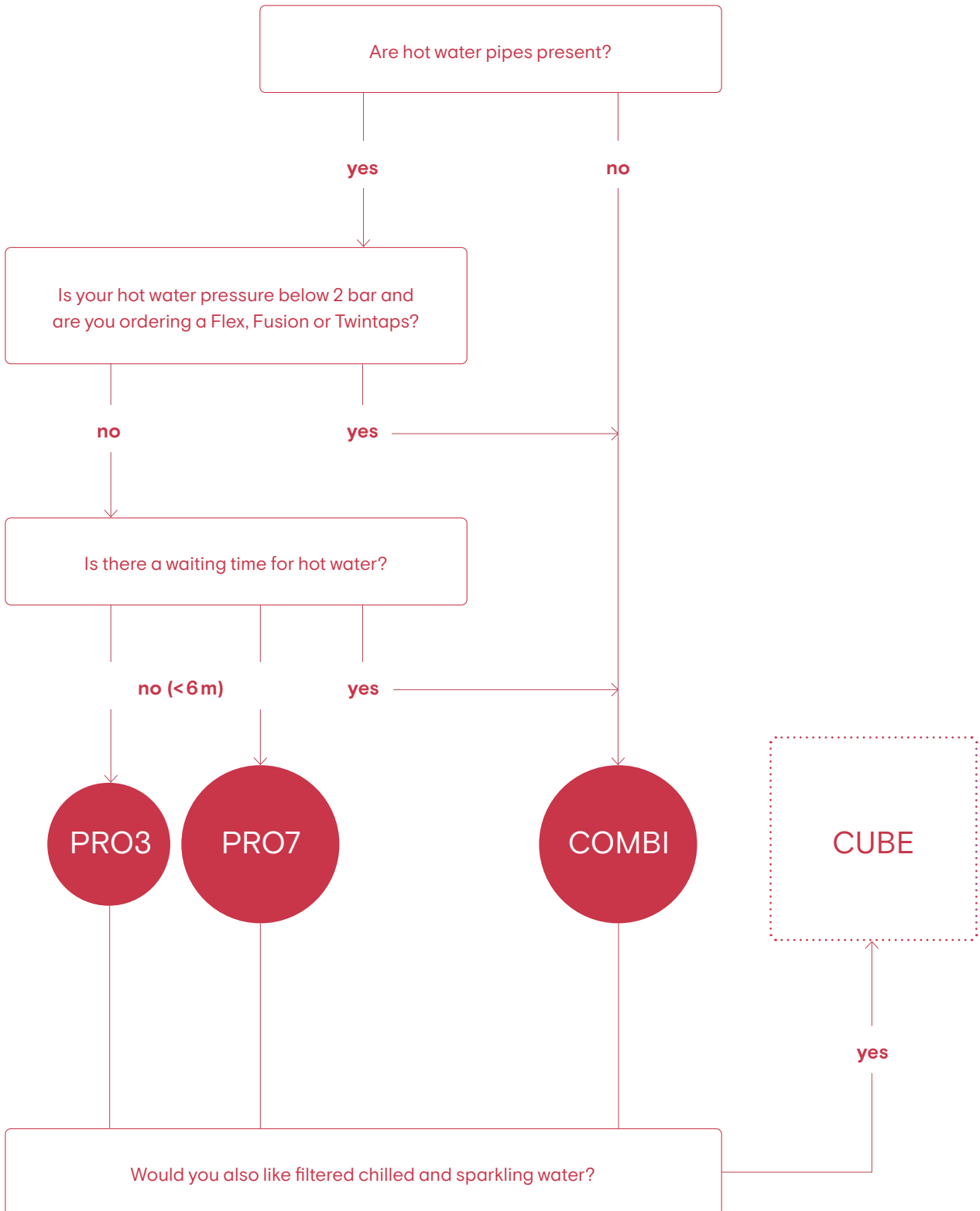



Flex stainless steel

Quooker CUBE



With the CUBE, your Quooker will dispense filtered chilled and sparkling water in addition to 100 °C boiling, hot and cold water. The CUBE contributes to sustainable living by eliminating the need to purchase single-use plastic bottles and helps to lower your carbon footprint by reducing supermarket visits. Not to mention, there will be no more carrying heavy bottles! With the CUBE you can make the most delicious lemonades and cocktails in no time, or just enjoy a glass of crisp, cold water.

The CUBE has a CO₂ cylinder attachment from which you can draw up to 60 litres of cold sparkling water. It will be placed at the bottom of your kitchen cupboard next to the existing boiling water tank. If you're short of plug sockets, we offer a Quooker Powerswitch. In addition to being handy, it also

prevents the circuit from overloading by switching the Quooker tank to standby mode if too much power is drawn from another appliance. The filtered chilled and sparkling water will still operate as normal.

Measurements

Height: 500 mm

Width: 153 mm*

Depth: 270 mm*

Chilling time: 30 min

Standby consumption: 5 W

* When the CO₂-cylinder is connected, 70 mm extra space is required at the front or side of the CUBE.

Measurements

Height: 230 mm

Diameter: 100 mm



Nordic Square Twintaps stainless steel

Accessories

Soap dispenser

This soap dispenser makes a great combination with a Quooker tap. It can be operated with one hand and is easy to fill from the top. This is the first soap dispenser that uses a patented ball bearing system and solid metal internals.



Cold Water Filter

The Cold Water Filter has been designed to allow you to quickly switch from tap water to cold filtered water. The Quooker tap supplies cold filtered water via a single push and turn which will light the tap ring blue. The water passes through an activated-carbon filter which ensures the water tastes and smells better. The filter is easy to replace and must be changed every 12 months. A Cold Water Filter is not necessary when you have purchased a CUBE.



Scale Control R

The Scale Control R has been developed to lengthen the lifespan of your Quooker, and reduces the hardness of the water to prevent limescale build-up in the tank. It is the most reliable descaling solution for the Quooker and improves the taste of the Quooker water.



Powerswitch

The Powerswitch for Quooker and CUBE is a three-way adaptor that will allow you to connect the Quooker tank, the Quooker CUBE and another appliance, for example a dishwasher, to the same socket. It prevents the circuit from overloading as it will detect when the third-party appliance is in use and will switch the Quooker tank to standby mode if too much power is drawn by the other appliance. The chilled filtered and sparkling water will operate as normal.





Classic Fusion Round patinated brass

A world class service and business philosophy



With over 40 years' experience and over 1 million installations, Quooker is the trusted name in the provision of 100 °C boiling, hot, cold, chilled and sparkling water. The business' DNA is all about providing an unparalleled world class service adopting a unique approach with a true desire to be the best in class at everything and anything we do.

A Quooker is easy to maintain which increases its longevity. Our taps typically last between fifteen and twenty years and all of our systems are maintained by a dedicated team guaranteeing a prompt and reliable service.

Sustainability is also at the centre of our DNA with people and protection of the planet at the forefront of our minds. Our factory is covered with 900 solar panels which supplies all of our energy needs! We recycle old products and manage our waste flows in a sustainable way.



Virtual appointment

With our virtual appointment service we will be able to guide you through our full collection, ensuring we find the system which best suits you!



Augmented reality

Quooker augmented reality allows you to virtually place the tap of your choice in your own kitchen in a fun and easy way. This way you can instantly visualise how any Quooker tap will look and fit your kitchen.



Quooker UK Ltd.
Beaumont Buildings
Great Ducie Street
Manchester M3 1PQ
+44 (0) 161 768 5900
enquiries@quooker.co.uk
www.quooker.co.uk
Contact us



45 years and 50 patents
further we are still ahead
and a Quooker in your kitchen
has become indispensable.



1970

When he was working on the development of a new, instant soup for an international food company, Henri Peteri realised that instant soup could never be truly instant if you didn't have boiling water at hand. From this point on he remained focused on the concept, working at home, in his basement, to develop a device to produce instant boiling water.



1976

The first series of tanks – 40 pieces.



1978

After he had taken out his seventh mortgage on his home, the financial resources he needed to work on his invention had been depleted. Henri Peteri was forced to discontinue his project and go back to earning a living for his family.



1970-1973

Despite his immense drive, he didn't manage to get any further than the prototype stage after several years of hard work. The appliance was hard to sell and broke down regularly.



1970-1976

The users of the prototypes were extremely enthusiastic. Those who had a Quooker could no longer do without it.



1972

The first patent



1976

The first series of taps 40 pieces were made with a safe detachable control knob.



1978

Prototype. IDEI design; The designers of the first Renault Espace.



1985

After completing his studies, Henri's son Niels began working in his father's cellar. The idea became a product and the Quooker was born.



1988

First set produced by Niels Peteri – 100 pieces.



1992

The Quooker Basic was launched in 1992. This was the first in a series of taps designed by Niels Peteri. The Classic followed in 1997, the Design in 1998 and the Modern in 2005.



1993

Reinforced with his son Walter, also a law graduate, the product was launched commercially.



1995

In December 1995 they bought a building on Staalstraat in Ridderkerk, even though the business was still making a loss. The adjacent buildings were purchased in 1998, 2001, 2002 and 2006 (including the mattress factory, which was turned into a production hall). And so, the Quooker continued to grow.

1997

The Classic. The first addition to the tap collection.



2000

The Quooker VAQ was launched in 2000. VAQ denotes the tank's revolutionary high-vacuum insulation. This insulation technology makes the Quooker highly energy- and compact, so that it can be easily fitted even in kitchens that have drawer units.



2004

In 2004, Quooker began exporting for the first time.

2005

For the introduction of the boiling water tap in the UK, we made a series of pictures showing only the tap and its uses against a black background. No kitchen setting, just huge white clouds of steam.

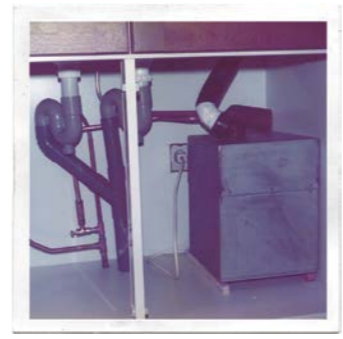

2006

The Quooker COMBI was introduced in 2006. Thanks to its insulation technology, the new model is 60% smaller and far more energy-efficient than other boiling or hot water equipment. More than half the Quookers now sold in the Netherlands are COMBI's.



2007

Henri Peteri died in 2007. During the last years of his life, he kept a low profile in the family business. What he considered to be his greatest achievement was that the three of them (Walter, Niels and himself) had worked so well together.

2010

Introducing the Twintaps, a combined boiling water and mixer tap in the same design.



2012

After a long lead-up, we launched the Fusion in 2012. Because we had to work hard to dispel the idea that boiling water straight from the tap could be unsafe, we were hesitant to develop an 'all-in-one tap'. But we bit the bullet and in May 2012 we started handing over the very first Fusions to our dealers in person.

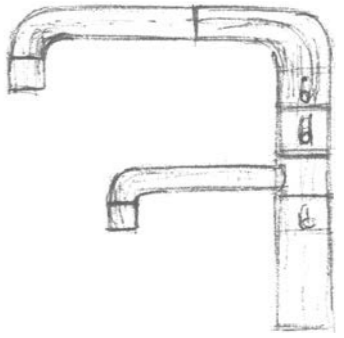

2016

In 2016 we built another new factory, our seventh expansion on the same locaton, doubling the working area to 11,000 m². The building is compact, combining both a modern manufacturing facility with an aesthetically attractive office space.

2016

Introducing FLEX. Another new function for our boiling water tap: a flexible hose for hot and cold water.



2018

In 2018 we opened the doors of our new office in Manchester.



2019

With the new CUBE, you can now also dispense chilled sparkling and filtered water from your Quooker tap.